

GOLV 2 - KLINKERS
1:10

EVENEMANG: YRKES SM 2026 STOCKHOLM			
PROJEKTNAMN: YRKESTÄVLINGAR_PLATTSÄTTNING			
RITAD AV: WILLIAM WINSTH <small>WORLDSKILLS SWEDEN EXPERT (CAD)</small>		IDÉ OCH DESIGN: FRIDA MALM <small>WORLDSKILLS SWEDEN EXPERT (PLATTSÄTTNING)</small>	
RITNINGS INNEHÅLL: GOLVPLAN - LAYOUT			DATUM: 2026-01-08
SKALA: 1 : 10		RITNINGNUMMER: SM-2601	

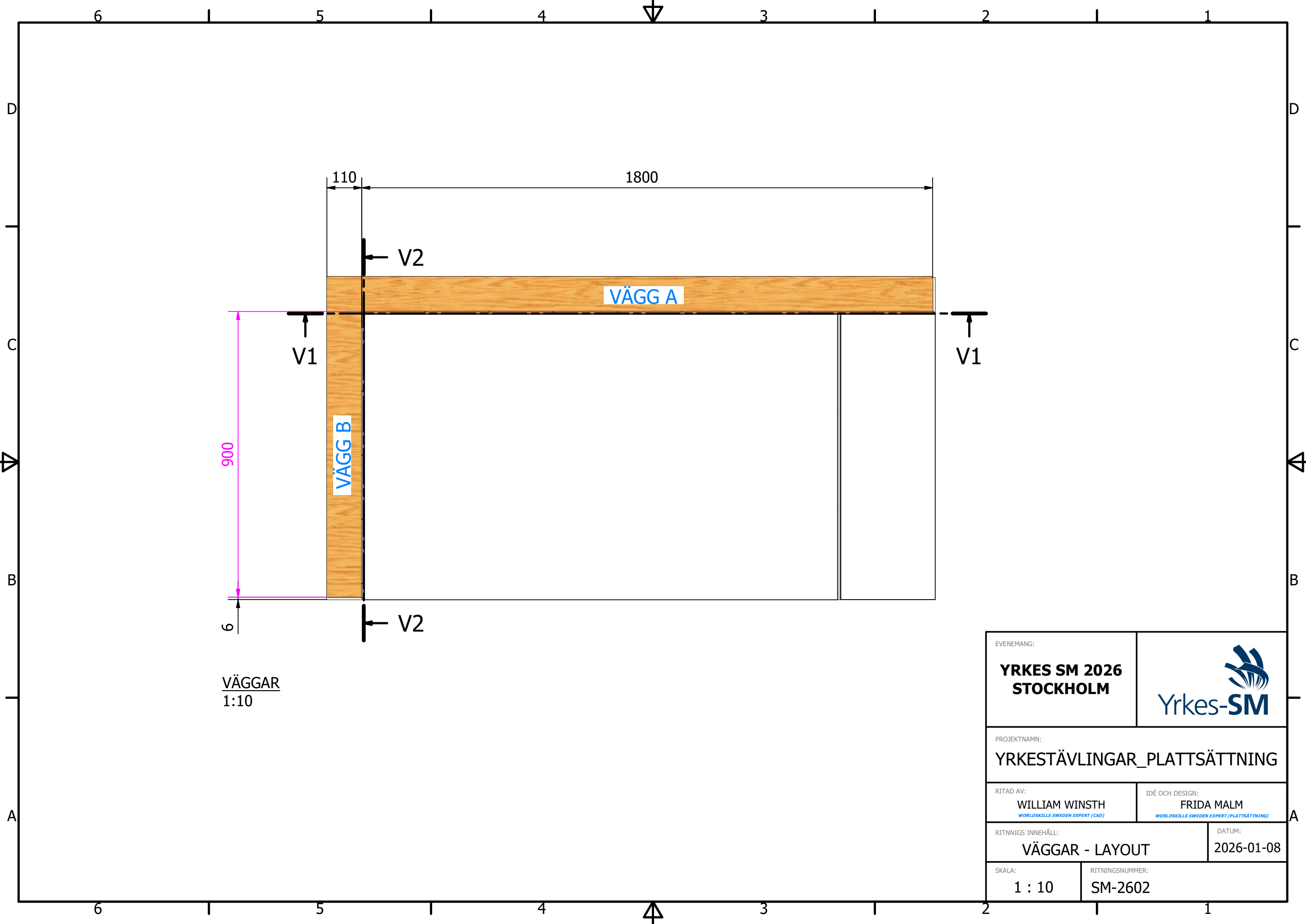

VÄGGAR
1:10

EVENEMANG: YRKES SM 2026 STOCKHOLM		
PROJEKTNAMN: YRKESTÄVLINGAR_PLATTSÄTTNING		
RITAD AV: WILLIAM WINSTH <small>WORLDSKILLS SWEDEN EXPERT (CAD)</small>	IDÉ OCH DESIGN: FRIDA MALM <small>WORLDSKILLS SWEDEN EXPERT (PLATTSÄTTNING)</small>	
RITNINGS INNEHÅLL: VÄGGAR - LAYOUT		DATUM: 2026-01-08
SKALA: 1 : 10	RITNINGSNUMMER: SM-2602	

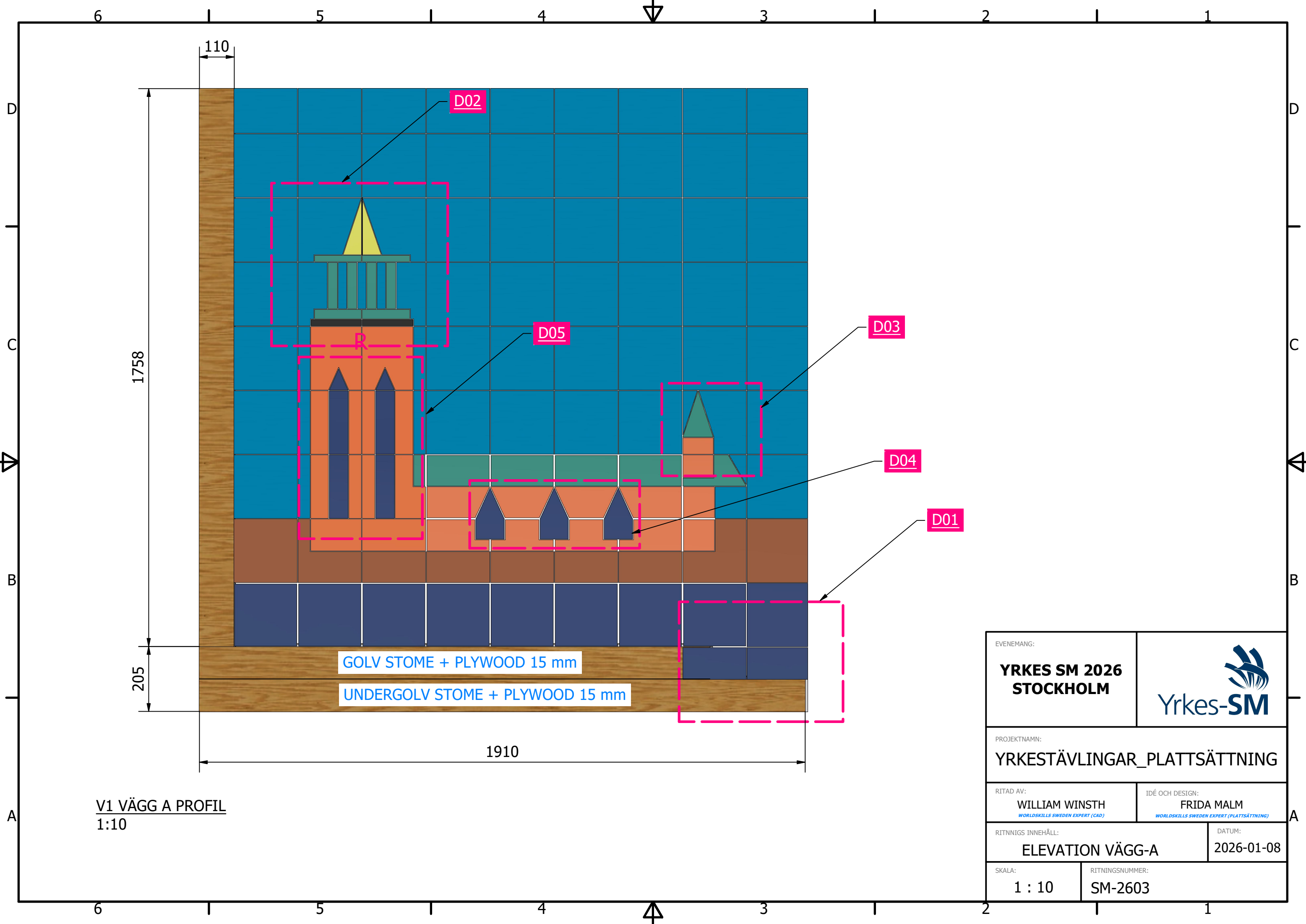

1758

205

110

GOLV STOME + PLYWOOD 15 mm

UNDERGOLV STOME + PLYWOOD 15 mm

1910

V1 VÄGG A PROFIL
1:10

D02

D05

D03

D04

D01

EVENEMANG: YRKES SM 2026 STOCKHOLM			
PROJEKTNAMN: YRKESTÄVLINGAR_PLATTSÄTTNING			
RITAD AV: WILLIAM WINSTH <small>WORLDSKILLS SWEDEN EXPERT (CAD)</small>		IDÉ OCH DESIGN: FRIDA MALM <small>WORLDSKILLS SWEDEN EXPERT (PLATTSÄTTNING)</small>	
RITNINGS INNEHÅLL: ELEVATION VÄGG-A			DATUM: 2026-01-08
SKALA: 1 : 10		RITNINGNUMMER: SM-2603	

D005 DETALJER FÖNSTER (1 : 5)

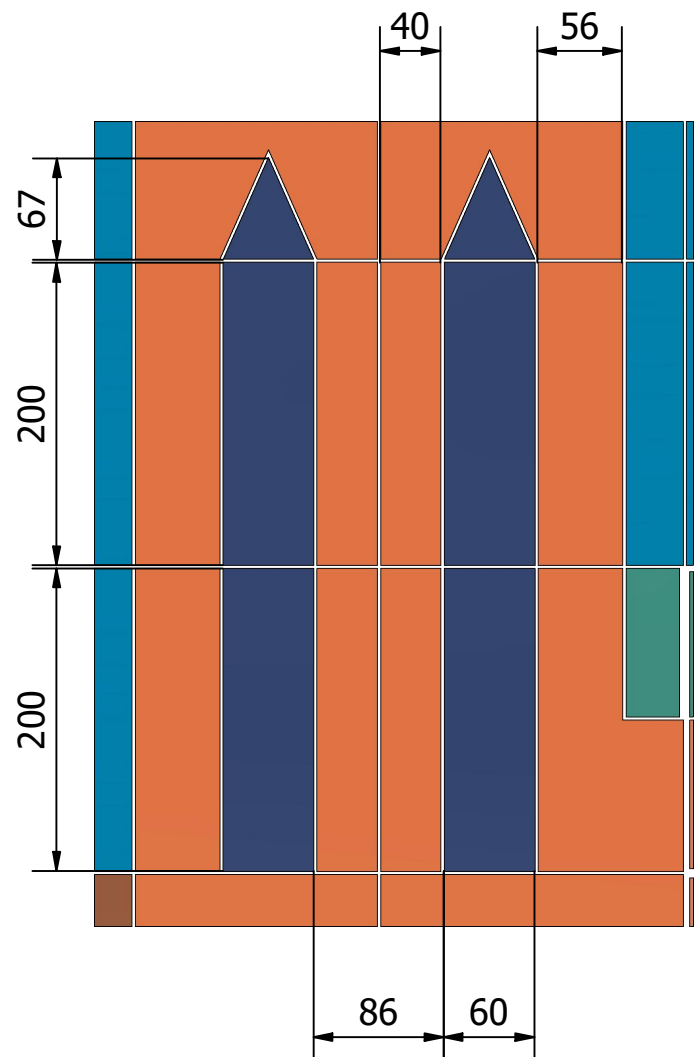

D03 DETALJER LITET TORN (1 : 5)

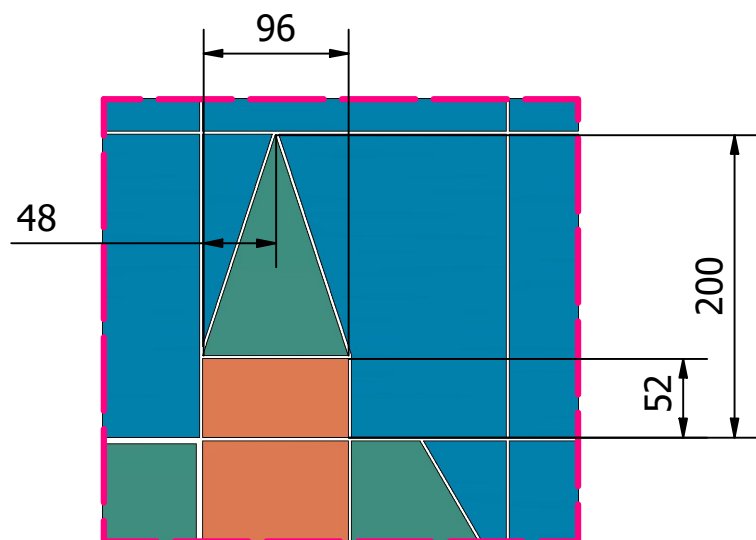

D02 DETALJER KLOCKTORNET (1 : 5)

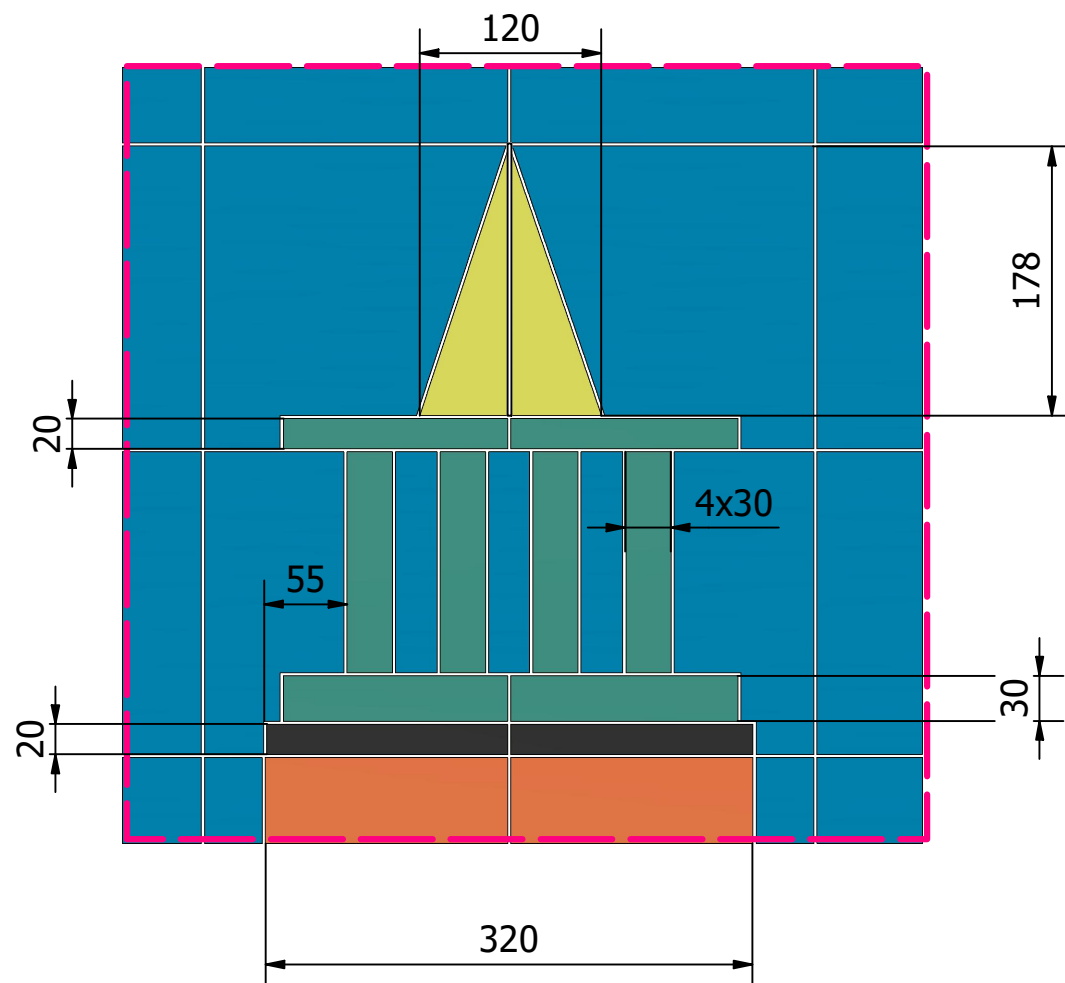

D04 DETALJER FÖNSTER (1 : 5)

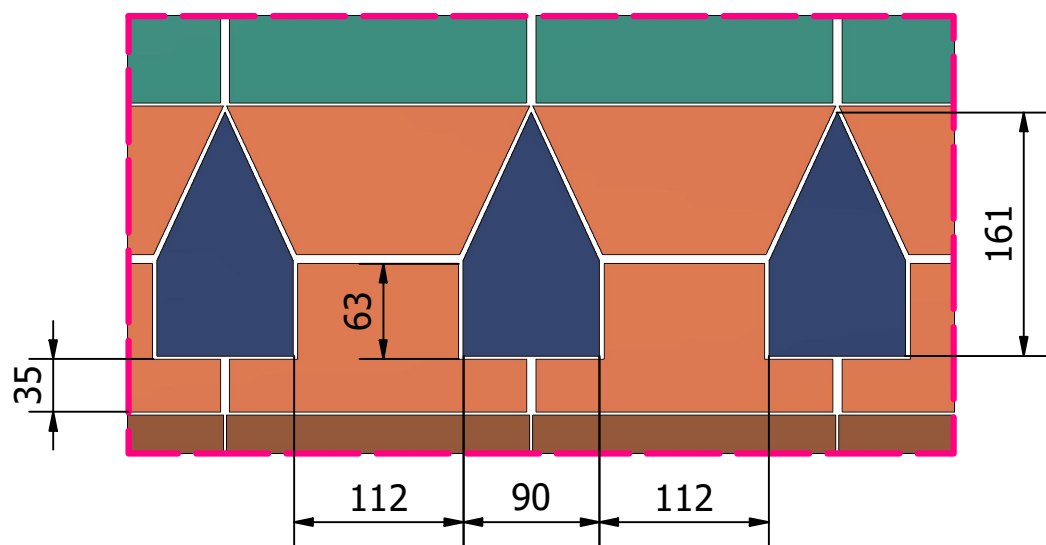

D01 DETALJER INNER- OCH YTTERRHÖRN (1 : 5)

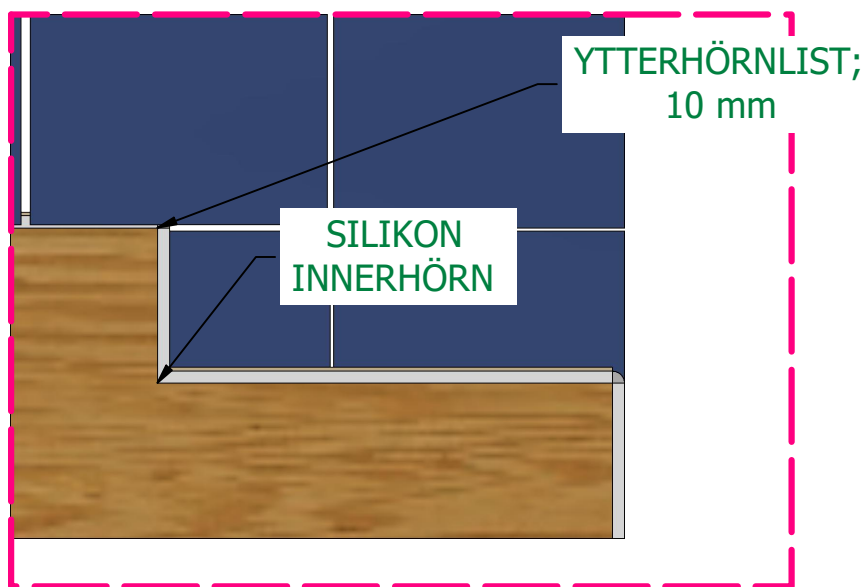

EVENEMANG: YRKES SM 2026 STOCKHOLM		
PROJEKTNAMN: YRKESTÄVLINGAR_PLATTSÄTTNING		
RITAD AV: WILLIAM WINSTH <small>WORLDSKILLS SWEDEN EXPERT (CAD)</small>	IDÉ OCH DESIGN: FRIDA MALM <small>WORLDSKILLS SWEDEN EXPERT (PLATTSÄTTNING)</small>	
RITNINGS INNEHÅLL: DETALJER 01, 02, 03 & 04		DATUM: 2026-01-08
SKALA: 1 : 5	RITNINGNUMMER: SM-2604	

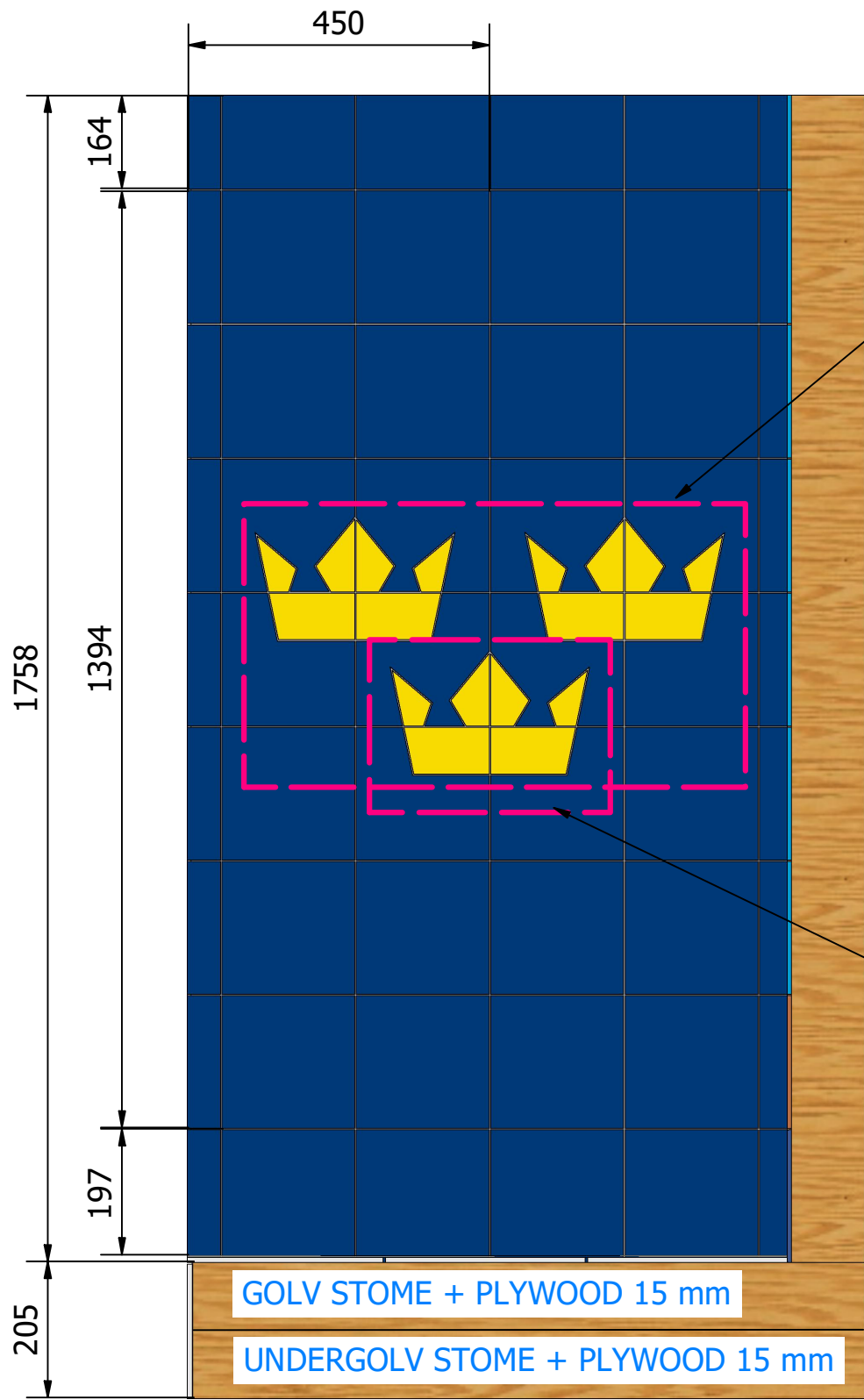

D06

D05

D06 (1 : 5)

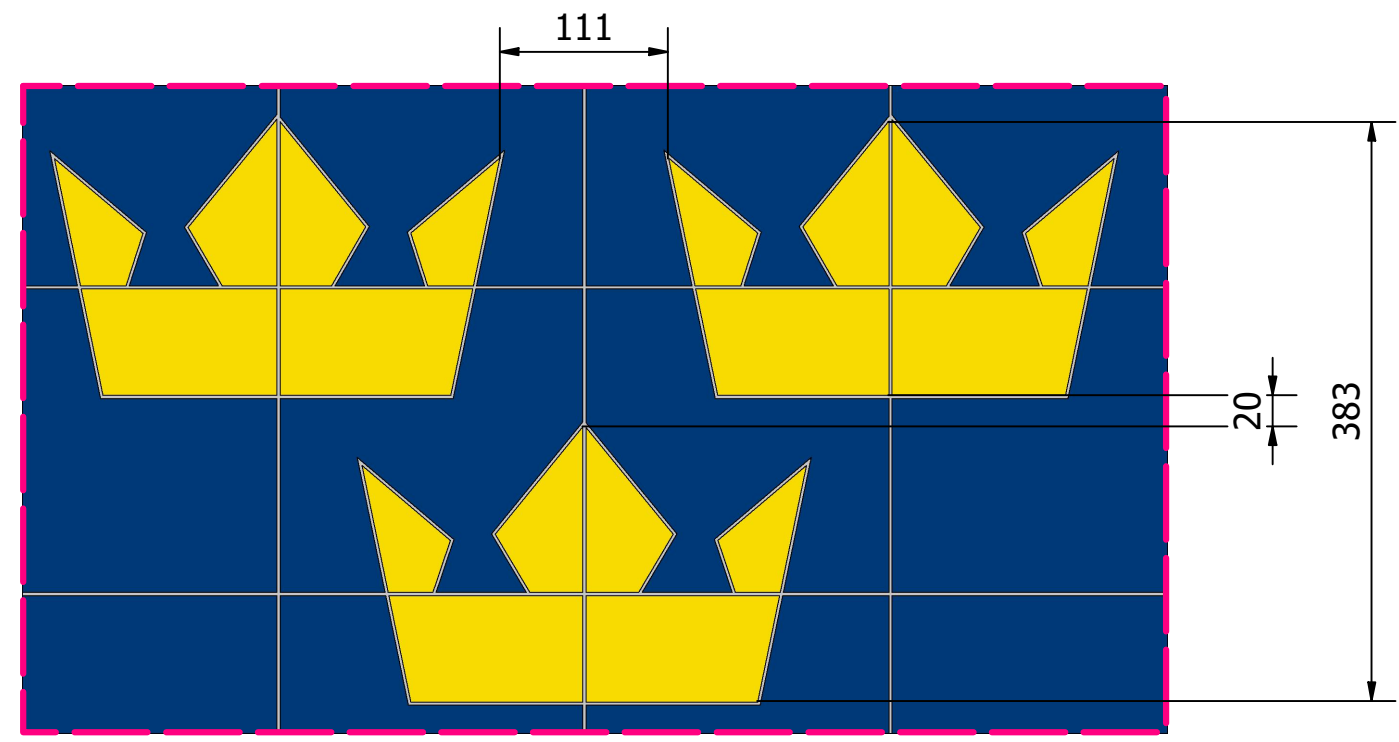

D05 (1 : 5)

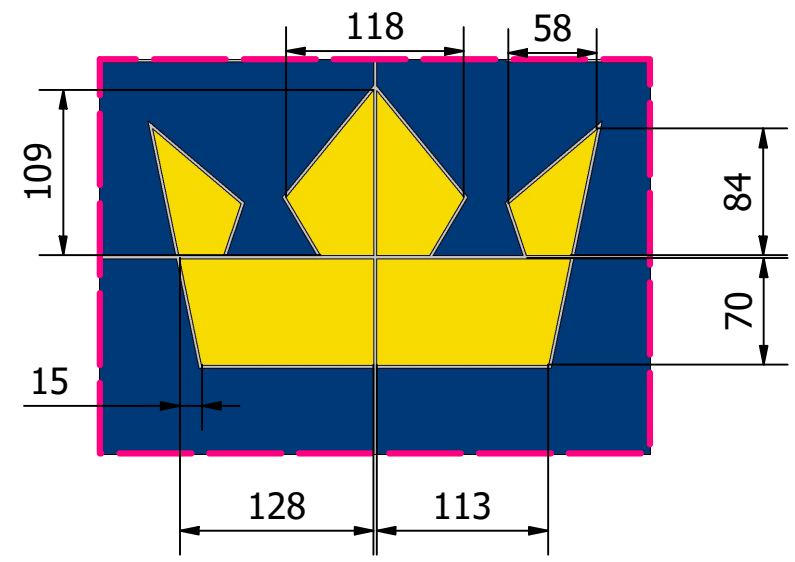

EVENEMANG: YRKES SM 2026 STOCKHOLM		
PROJEKTNAMN: YRKESTÄVLINGAR_PLATTSÄTTNING		
RITAD AV: WILLIAM WINSTH <small>WORLDSKILLS SWEDEN EXPERT (CAD)</small>	IDÉ OCH DESIGN: FRIDA MALM <small>WORLDSKILLS SWEDEN EXPERT (PLATTSÄTTNING)</small>	
RITNINGS INNEHÅLL: ELEVATION VÄGG-B & DETALJER		DATUM: 2026-01-08
SKALA: 1 : 10	RITNINGNUMMER: SM-2605	

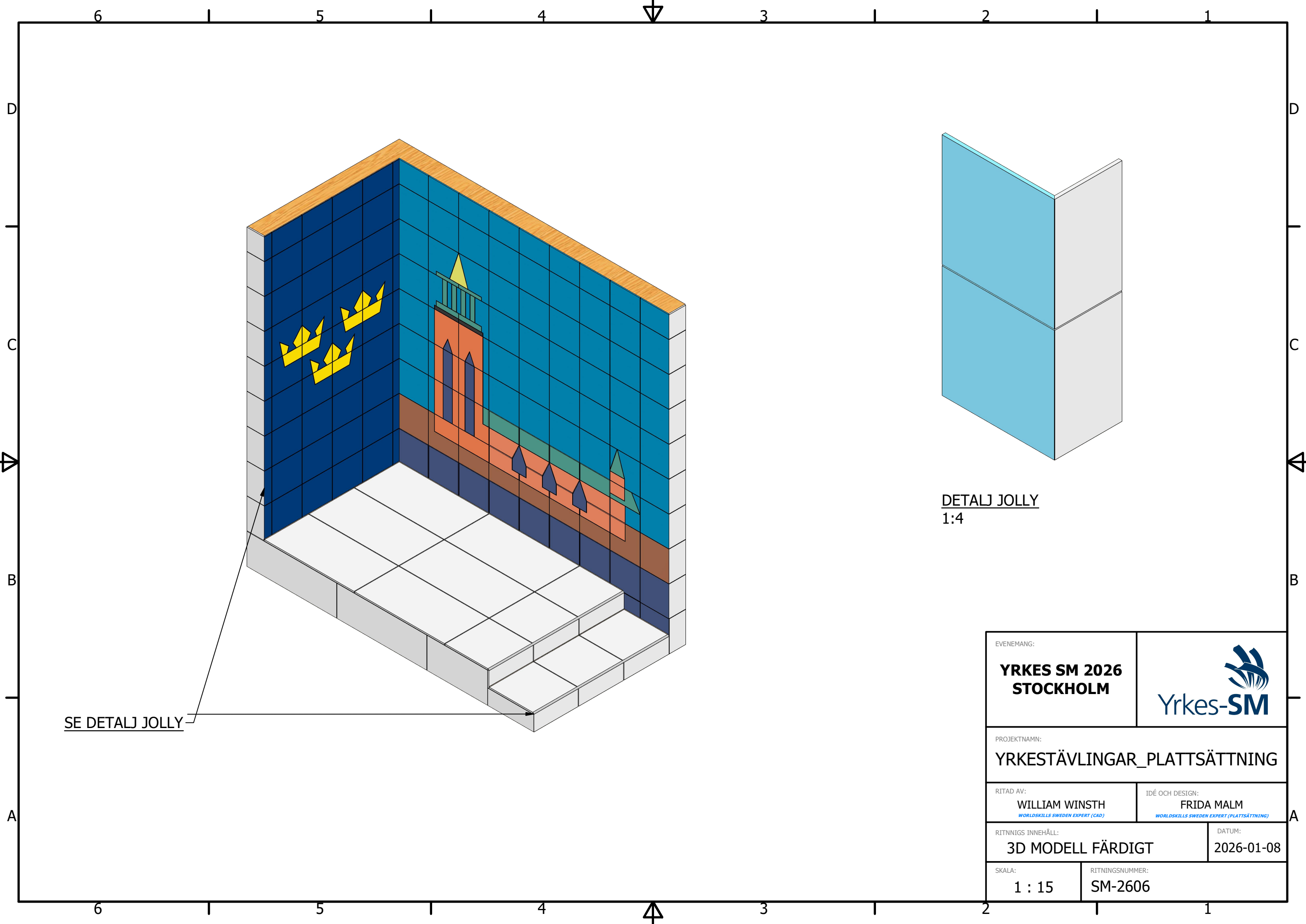

SE DETALJ JOLLY

DETALJ JOLLY
1:4

EVENEMANG: YRKES SM 2026 STOCKHOLM		
PROJEKTNAMN: YRKESTÄVLINGAR_PLATTSÄTTNING		
RITAD AV: WILLIAM WINSTH <small>WORLDSKILLS SWEDEN EXPERT (CAD)</small>	IDÉ OCH DESIGN: FRIDA MALM <small>WORLDSKILLS SWEDEN EXPERT (PLATTSÄTTNING)</small>	
RITNINGS INNEHÅLL: 3D MODELL FÄRDIGT		DATUM: 2026-01-08
SKALA: 1 : 15	RITNINGNUMMER: SM-2606	

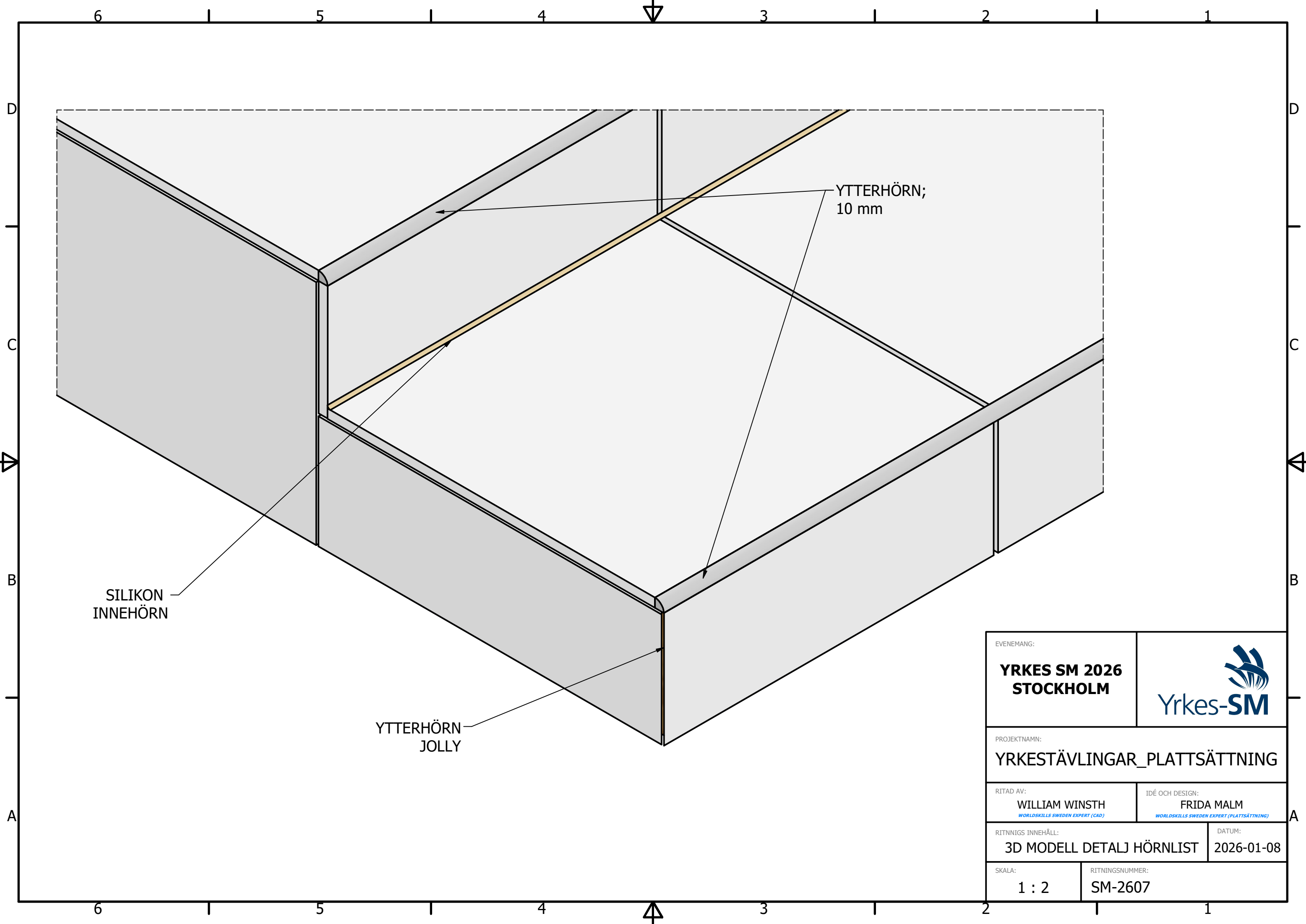

SILIKON
INNEHÖRN

YTTERHÖRN;
10 mm

YTTERHÖRN
JOLLY

EVENEMANG: YRKES SM 2026 STOCKHOLM			
PROJEKTNAMN: YRKESTÄVLINGAR_PLATTSÄTTNING			
RITAD AV: WILLIAM WINSTH <small>WORLDSKILLS SWEDEN EXPERT (CAD)</small>		IDÉ OCH DESIGN: FRIDA MALM <small>WORLDSKILLS SWEDEN EXPERT (PLATTSÄTTNING)</small>	
RITNINGS INNEHÅLL: 3D MODELL DETALJ HÖRNLIST			DATUM: 2026-01-08
SKALA: 1 : 2		RITNINGNUMMER: SM-2607	

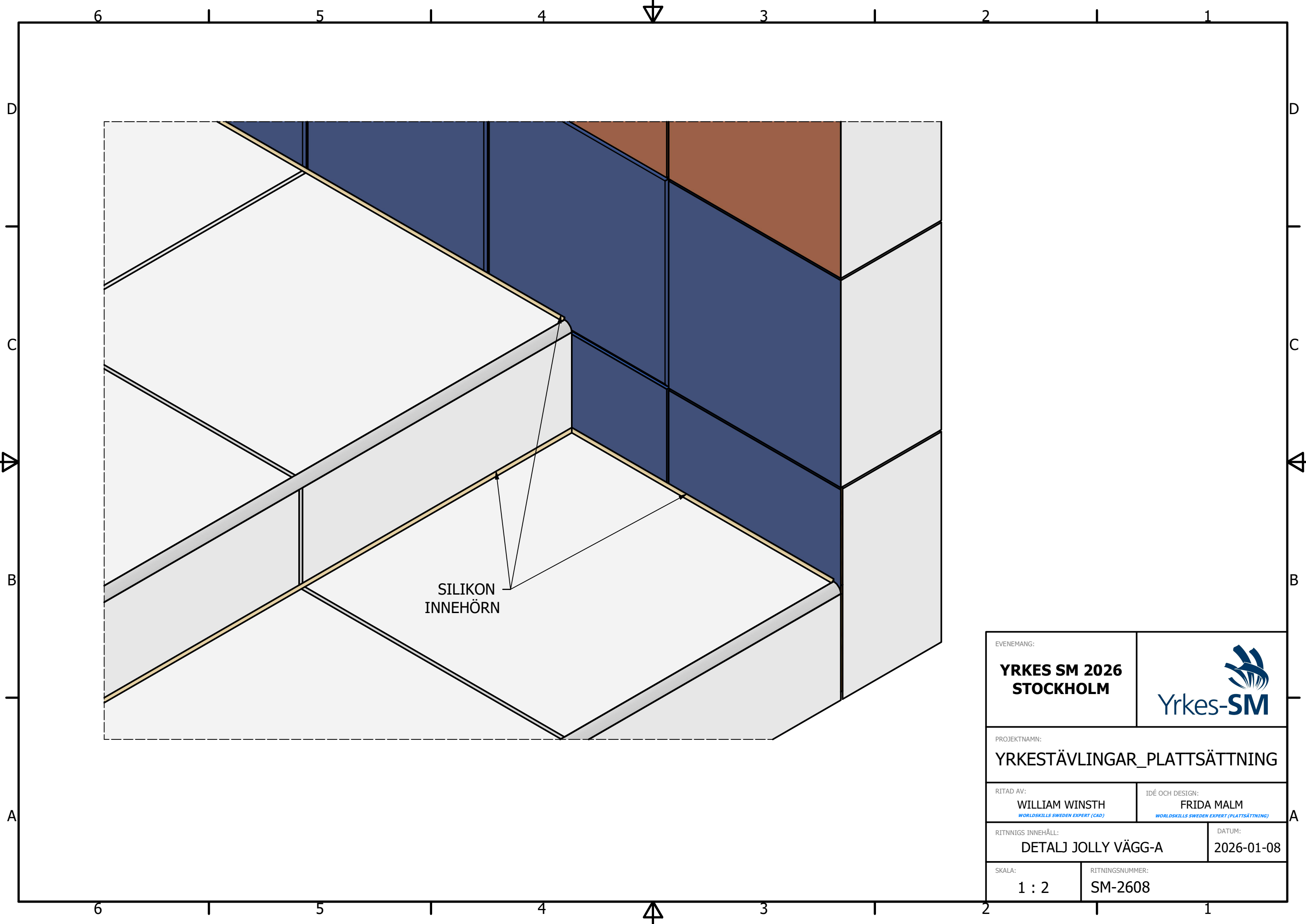

SILIKON
INNEHÖRN

EVENEMANG: YRKES SM 2026 STOCKHOLM			
PROJEKTNAMN: YRKESTÄVLINGAR_PLATTSÄTTNING			
RITAD AV: WILLIAM WINSTH <small>WORLDSKILLS SWEDEN EXPERT (CAD)</small>		IDÉ OCH DESIGN: FRIDA MALM <small>WORLDSKILLS SWEDEN EXPERT (PLATTSÄTTNING)</small>	
RITNINGS INNEHÅLL: DETALJ JOLLY VÄGG-A			DATUM: 2026-01-08
SKALA: 1 : 2		RITNINGNUMMER: SM-2608	

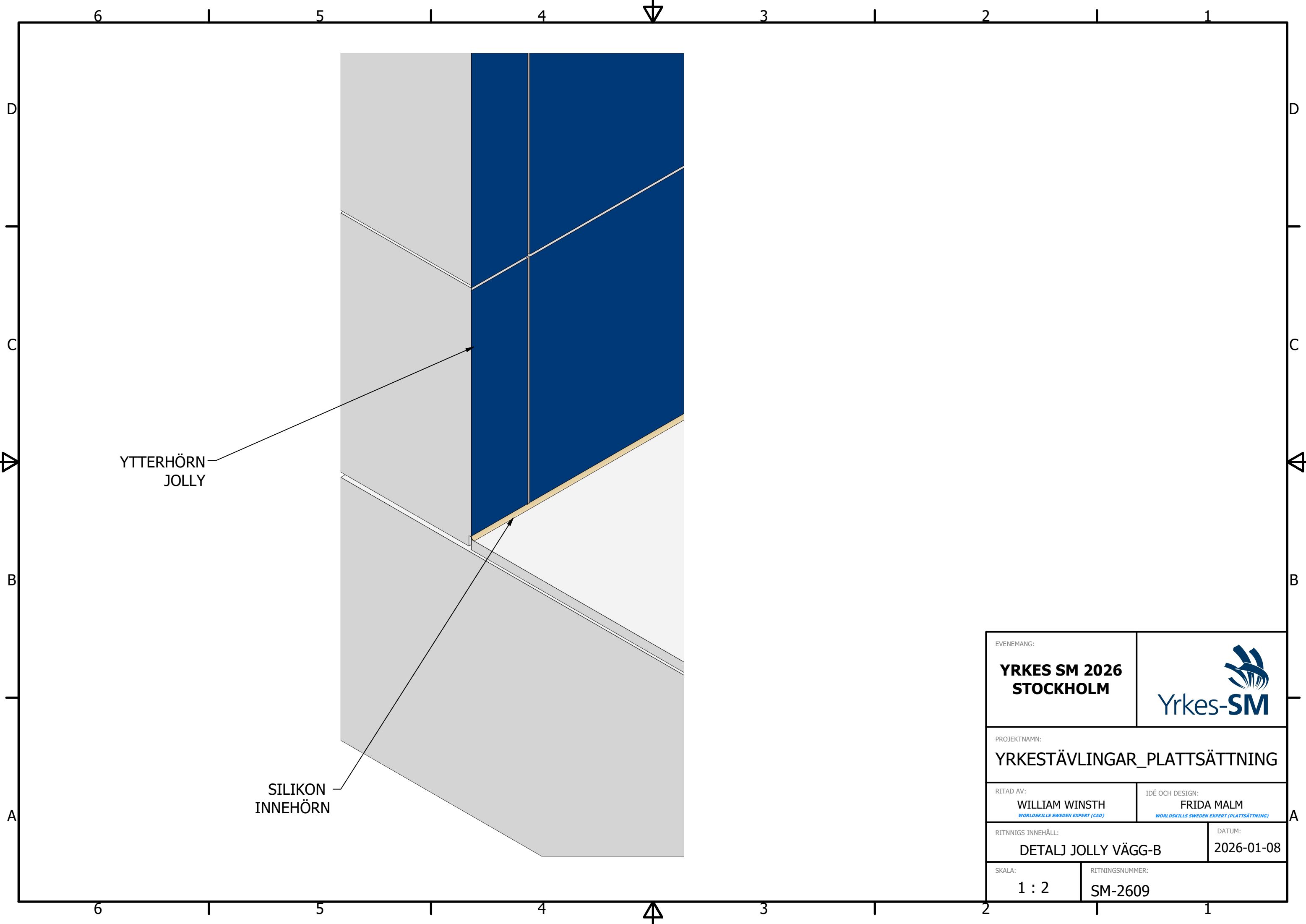

Ytterhörn
JOLLY

SILIKON
INNEHÖRN

EVENEMANG: YRKES SM 2026 STOCKHOLM			
PROJEKTNAMN: YRKESTÄVLINGAR_PLATTSÄTTNING			
RITAD AV: WILLIAM WINSTH <small>WORLDSKILLS SWEDEN EXPERT (CAD)</small>		IDÉ OCH DESIGN: FRIDA MALM <small>WORLDSKILLS SWEDEN EXPERT (PLATTSÄTTNING)</small>	
RITNINGS INNEHÅLL: DETALJ JOLLY VÄGG-B			DATUM: 2026-01-08
SKALA: 1 : 2		RITNINGNUMMER: SM-2609	